

CATALOG NUMBER	TYPE
PROJECT	

3" LOW VOLTAGE DOWNLIGHT HOUSING

HR-302M

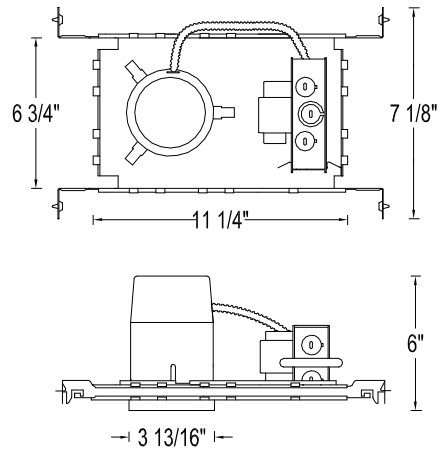
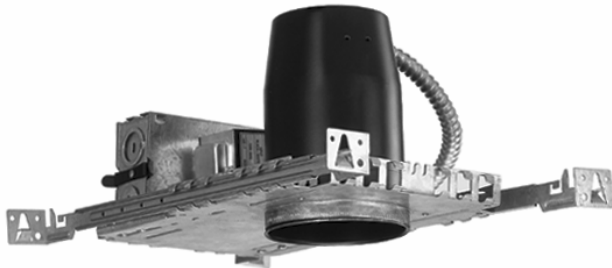

Ordering Matrix			
Series	Model Number	Transformer Type	Trim
[]	[]	[]	
HR	302	M	See page two

Ordering Example (series – model number – transformer type + trim): HR-302M

Product Details	
Description:	Low voltage new construction downlight with integral magnetic transformer.
Materials:	Housing is 20 gauge steel, painted black. Frame, junction box and hanger bars are heavy gauge galvanized steel. Electrical component within can is a bi-pin ceramic socket with 18 gauge teflon insulated wires with fiberglass sleeves.
J-Box:	Seven 1/2" knockouts and four integral Romex connectors provided for ease of installation. Rated for branch and chain wiring.
Lamp & Transformer:	Magnetic transformer for 12 volt MR16 lamps, 50w maximum. 120V input transformer.
Ratings:	Non-IC rated. Insulation must be kept at least 3" away from the housing. U.L. and C.U.L. listed. Suitable for damp locations
Mounting:	Supplied with hanger bars, adjustable from 12"-24" to accommodate various joist construction and grid sizes. Hanger bars have slots for easy mounting on "T" bars. Accommodates surface thickness of up to 3/4". 3 7/8" cutout hole.
Thermal Protection:	Thermal protector supplied with HR-302M protects against over-lamping.







Specification Features
<ul style="list-style-type: none"> • Small sized remodeling housing is compact enough to fit in most joist installations, allowing these to be used in "shallow" applications such as 2-story houses or where attic space is used for storage. • Downlights feature long-life magnetic transformers with proven core and coil technology. • Dimmable with magnetic low voltage dimmers. • 5 year WAC Lighting product warranty.

CATALOG NUMBER	TYPE
PROJECT	

3" LOW VOLTAGE DOWNLIGHT HOUSING

HR-301E

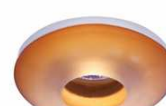
Compatible Trims (sold separately):

<p>HR-D321-□□□□</p> <p>Finishes: BK/WT, SC/BN, SC/WT</p> <p>Lamp: MR16 50W</p>		<p>HR-D324-□□□□</p> <p>Finishes: BK/BN, BK/WT, WT/WT</p> <p>Lamp: MR16 50W</p>		<p>HR-D327-□□</p> <p>Finishes: BK, BN, WT</p> <p>Lamp: MR16 50W</p>	
<p>HR-D329-□□</p> <p>Finishes: CB, WT</p> <p>Lamp: MR16 35W or Xenon 50W</p>		<p>HR-D325-□□□□</p> <p>Finishes: BK/WT, WT/WT</p> <p>Lamp: MR16 35W</p>		<p>HR-D326-□□</p> <p>Finishes: BK, BN, WT</p> <p>Lamp: MR16 50W</p>	
<p>HR-D332-□□</p> <p>Finishes: AM, WT</p> <p>Lamp: MR16 50W</p>		<p>HR-D333-□□□□</p> <p>Finishes: AM/WT, WT/WT</p> <p>Lamp: MR16 50W</p>		<p>HR-D334-□□</p> <p>Finishes: BN, WT</p> <p>Lamp: MR16 50W</p>	

Finish Key:
AM-Amber, BK-Black, BN-Brushed Nickel, CB-Copper Bronze, CH-Chrome, SC-Specular Clear, WT-White

Notes: **The full catalog number for a complete downlight includes the model numbers for both the trim and the housing.**

More information regarding each individual trim can be viewed on the individual trim spec sheets.