

INSTALLATION INSTRUCTION

400 Series LED Quick Connect™ Socket Set

QP-LED403, MP-LED403

WAC LIGHTING

Responsible Lighting®

OVERVIEW:

Pendant socket sets are designed for use with all WAC quick connect adapters. They may also be used on other manufacturers brand of quick connect (consult factory for compatibility). Pendants may be mounted to mono rail, monopoints, or line volt track, by coupling to a low voltage quick connect adapter.

QP-LED403 includes 6 feet of cable. QP- LED403X12 includes 12 feet of cable.

Pendant socket sets can be field cut to desired length.

INSTALLING SHADE:

1. Socket Set QP-LED403 is designed to be used with WAC's G491, G492 and G493 glass shades.
2. Insert glass into fitter. Align the 3 holes in the glass shade with the holes in the fitter.
3. Carefully turn the screws through the holes in the fitter into the holes in the glass shade to secure glass.

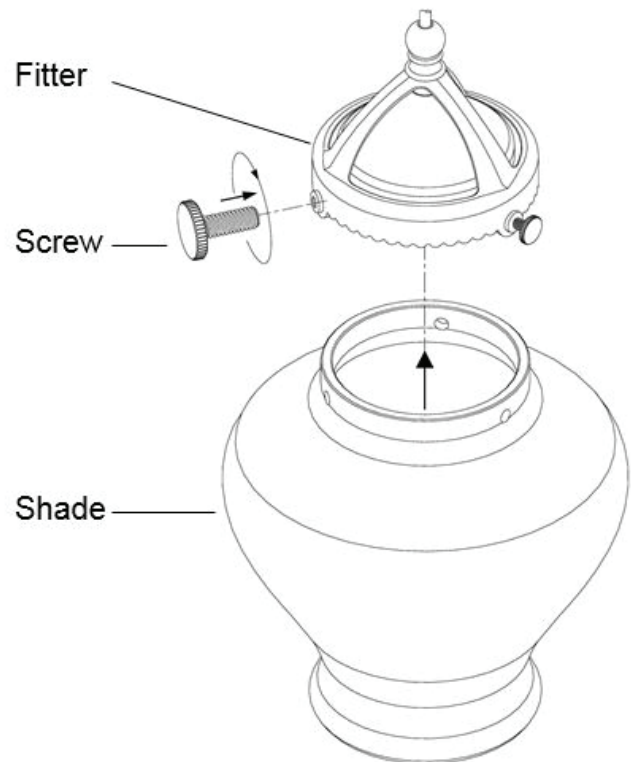

INSTALLING QUICK CONNECT:

1. Insert the post of the quick connect into the quick connect adapter.
2. Thread the top half of the conical section until it seats with the adapter.
3. Adjust fixture position, use caution not to loosen the conical section

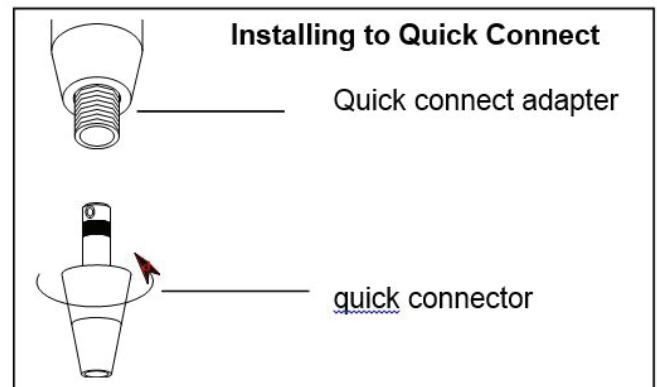

WAC Lighting
www.waclighting.com
Phone (800) 526.2588 • Fax (800) 526.2585

Headquarters/Eastern Distribution Center
44 Harbor Park Drive • Port Washington, NY 11050
Phone (516) 515.5000 • Fax (516) 515.5050

Western Distribution Center
1750 Archibald Ave • Ontario, CA 91761
Phone (800) 526.2588 • Fax (800) 526.2585

INSTALLATION INSTRUCTION
400 Series LED Quick Connect™ Socket Set
QP-LED403, MP-LED403

WAC LIGHTING
Responsible Lighting®

TO INSTALL / SHORTEN THE CABLE:

Feed the cable end through the Top Conical section and the metal finial. If cable needs to be shortened, make the cut now. To install the top conical section, follow the step-by-step instructions bellow. **NOTE: Pendant cables are co-axial, if the lower screw in step 4 is made too tight, the inner an outer wire will short. A short circuit will render the entire system in-operative and possibly damage the transformer. Check all pendant splices for continuity before installing.**

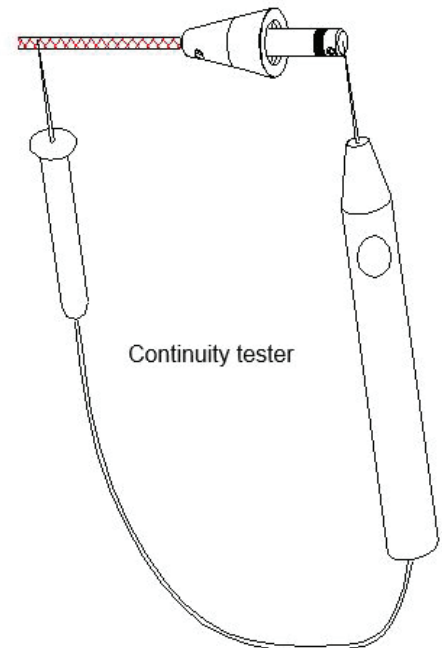
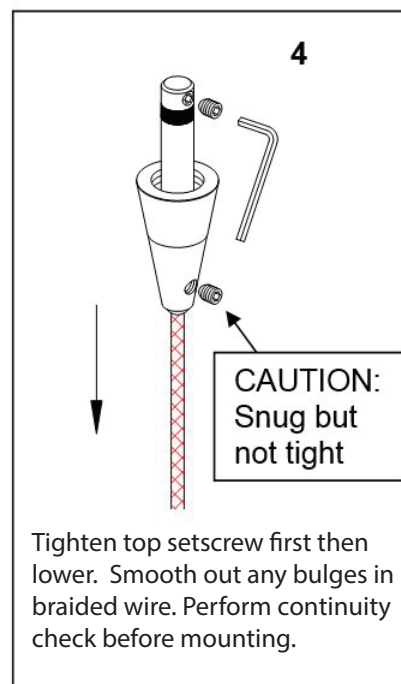
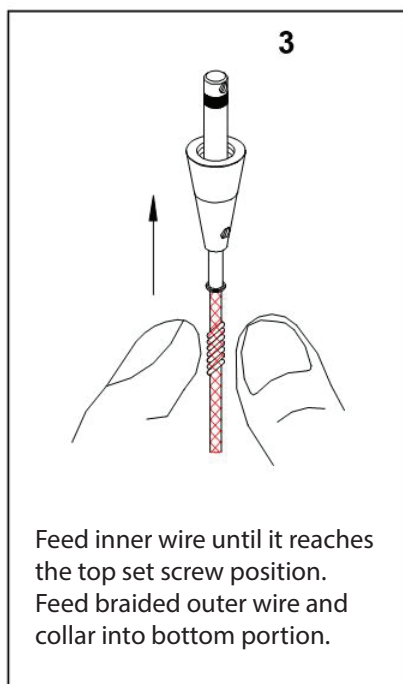
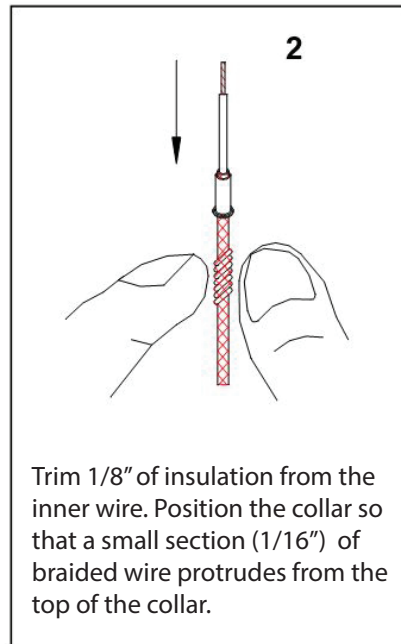
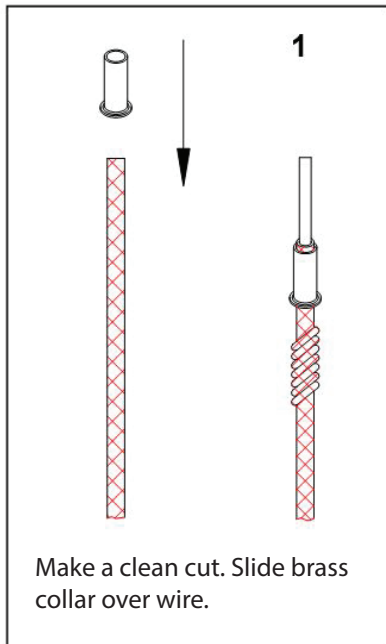

CHECK SPLICE:

Before mounting, with lamp removed from the socket, check for continuity. There should be none.

Insert lamp in socket and re-check. There should now be continuity, indicating a completed circuit.

Install with power off.

WAC Lighting
www.waclighting.com
Phone (800) 526.2588 • Fax (800) 526.2585

Headquarters/Eastern Distribution Center
44 Harbor Park Drive • Port Washington, NY 11050
Phone (516) 515.5000 • Fax (516) 515.5050

Western Distribution Center
1750 Archibald Ave • Ontario, CA 91761
Phone (800) 526.2588 • Fax (800) 526.2585