

WAC LIGHTING

Low Voltage Multiple Spots

3 Light Trim Without Lamp

Model	Finish
MT-316	WT/WT White/White
MT-316TL	WT White

Example: **MT-316-WT/WT**

DESCRIPTION

Low Voltage Multiple Spots are ideal for perimeter lighting applications in smaller scale retail, commercial and hospitality environments. Square single light gimbal ring style adjustable recessed fixture, available with flanged trim or Invisible Trim™, designed to sit flush with the ceiling for a clean architectural look. Housing, trim, and lamp are sold separately.

FEATURES

- Trim version has a 1/4" low profile, Invisible Trim™ sits flush to ceiling
- The supplied clear glass lens can be replaced by a variety of lenses or accessories
- 5 year warranty

SPECIFICATIONS

Construction:	Stamped metal trim
Power:	150W
Light Source:	LED MR16 (Order separately)
Cut Out:	Trimless : 5 5/8" x 13 3/4", Trim : 5 3/16" x 13 1/4"
Finish:	Electrostatically Powder Coated: White, Electrostatically Powder Coated: White/White
Standards:	UL, cUL, Damp Location Listed

Fixture Type: _____

Catalog Number: _____

Project: _____

Location: _____



FINISHES:



LINE DRAWING:

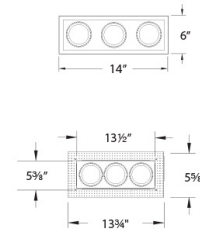

WAC LIGHTING

Low Voltage Multiple Spots

3 Light Housing

Model & Product

MT-316HS Low Voltage Multiple Three
Light Non-IC Housing

Example: **MT-316HS**

DESCRIPTION

Low Voltage Multiple Spots are ideal for perimeter lighting applications in smaller scale retail, commercial and hospitality environments. Square single light gimbal ring style adjustable recessed fixture, available with flanged trim or Invisible Trim™, designed to sit flush with the ceiling for a clean architectural look. Housing, trim, and lamp are sold separately.

FEATURES

- Electronic short circuit and overload protection with automatic reset
- Soft start to prolong lamp life
- Transformer concealed within the fixture
- 5 year warranty

SPECIFICATIONS

Construction:	Aluminum hardware with mouth blown etched glass diffuser
Input:	120 VAC, 50/60Hz
Dimming:	ELV: 100-10%
Light Source:	Halogen or LED MR16
Mounting:	Supplied with hanger bars, adjustable from 15"-24 1/2" to accommodate various joist construction and grid sizes
Ceiling Thickness:	1/2" - 1"
Standards:	UL, cUL, Damp Location Listed, Non IC

Fixture Type: _____

Catalog Number: _____

Project: _____

Location: _____



LINE DRAWING:

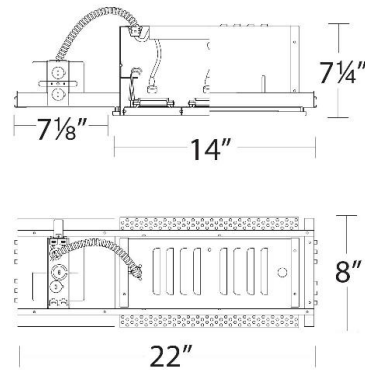

WAC LIGHTING

Low Voltage Multiple Spots 3 Light Trim Without Lamp







Fixture Type: _____

Catalog Number: _____

Project: _____

Location: _____

ACCESSORIES

	<i>Model</i>	<i>Description</i>	<i>Finish</i>
	LENS-16-RED LENS-16-GRN LENS-16-BLU LENS-16-AMB	Colored Lens Colored Lens Colored Lens Colored Lens	Red Green Blue Amber
	LENS-16-FR	Clear/Frosted Lens	Frosted
	LENS-16-SPR	Spread Lens	Spread Lens
	LENS-16-UVF	UV Filter lens	Clear
	LENS-16-BEL	Beam Elongating Lens	Beam Elongating
	LENS-16-HCL	Honeycomb Louver	Black