

INSTALLATION INSTRUCTION

LEDme Multiple Spot

MT-LED118, MT-LED218, MT-LED318, MT-LED418, MT-LED228

WAC LIGHTING

Responsible Lighting®

OVERVIEW:

Housing is new construction type. Housing requires a trim or invisible trim. May be used with a standard incandescent dimmer switch, or an electronic low voltage dimmer.

MOUNTING:

1. Install mounting frame using two hanger bars, (24 1/2" max). Bars are notched on the ends to fit over "T" bars in suspended ceilings. Hanger bars include a captive mounting "screw-nail" for ease of installation (as Fig.1). Align the bottom of the hanger bar with the bottom of the wood joist. Secure the "screw-nail" on each end by screwdriver (as Fig. A), or by hammer (as Fig. B).
2. Slide fixture along bar hangers into desired location. Use locking screws to secure (as Fig. C).
3. Junction box is suitable for branch wiring and has trade size knockout and integral non-metallic sheathed cable connectors.
4. Remove spring latched junction box door and connect fixture wires to building wires: insert each supply wire into appropriate junction box connector. Connect black fixture wire to hot, white fixture wire to neutral and green fixture wire to ground (as Fig.2).
5. Place all wiring and connectors back in wiring box and replace junction box door.
6. When installing in drywall, cut a hole in the drywall (see the following form). After installing drywall, if necessary, adjust fixture for ceiling thickness by loosening screws that attach the square housing to the plaster frame (as Fig.3 and Fig.4).

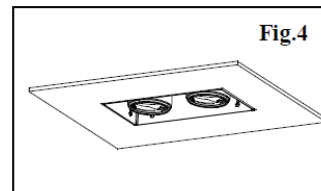
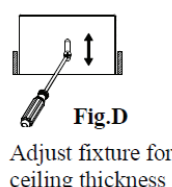
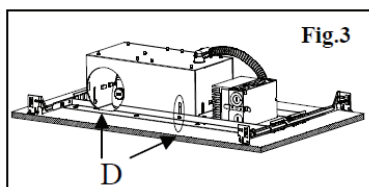
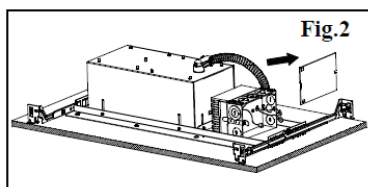
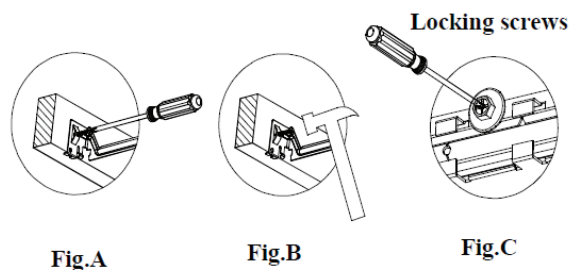
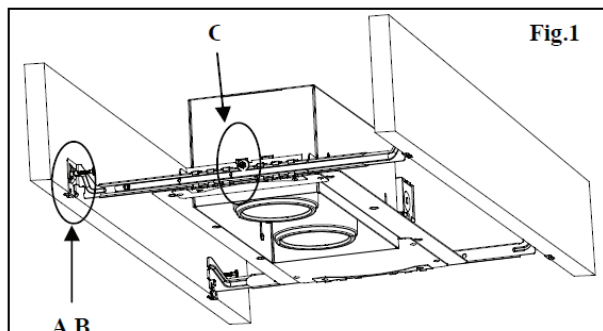

USE TEMPLATE SUPPLIED TO MAKE APPROPRIATE CUTOUT FOR TRIM INSTALLATION.

MODEL	TRIM	CUTOUT	INVISIBLE TRIM	CUTOUT
MT-LED118S-WWHS MT-LED118S-CWHS MT-LED118F-WWHS MT-LED118F-CWHS	MT-LED118	6"x6"	MT-LED118TL	6 1/2" x 6 1/2"
MT-LED218S-WWHS MT-LED218S-CWHS MT-LED218F-WWHS MT-LED218F-CWHS	MT-LED218	11 3/4" x 6"	MT-LED218TL	12 1/4" x 6 1/2"
MT-LED318S-WWHS MT-LED318S-CWHS MT-LED318F-WWHS MT-LED318F-CWHS	MT-LED318	17 3/8" x 6"	MT-LED318TL	17 7/8" x 6 1/2"
MT-LED418S-WWHS MT-LED418S-CWHS MT-LED418F-WWHS MT-LED418F-CWHS	MT-LED418	23 1/8" x 6"	MT-LED418TL	23 5/8" x 6 1/2"
MT-LED228S-WWHS MT-LED228S-CWHS MT-LED228F-WWHS MT-LED228F-CWHS	MT-LED228	11 3/4" x 11 3/4"	MT-LED228TL	12 1/4" x 12 1/4"

WAC Lighting
www.waclighting.com
Phone (800) 526.2588 • Fax (800) 526.2585

Headquarters/Eastern Distribution Center
44 Harbor Park Drive • Port Washington, NY 11050
Phone (516) 515.5000 • Fax (516) 515.5050

Western Distribution Center
1750 Archibald Ave • Ontario, CA 91761
Phone (800) 526.2588 • Fax (800) 526.2585

INSTALLATION INSTRUCTION

LEDme Multiple Spot

MT-LED118, MT-LED218, MT-LED318, MT-LED418, MT-LED228

WAC LIGHTING

Responsible Lighting®

TO INSTALL TRIM

- Raise the trim to the housing and attach two sides by securing the torsion spring in the anchor cleat (as Fig.5).
- Place socket in the trim hole and depress socket springs to clip in place (as Fig. E).
- Push trim flush up against the ceiling (as Fig.6).

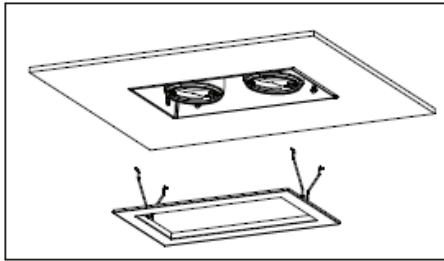
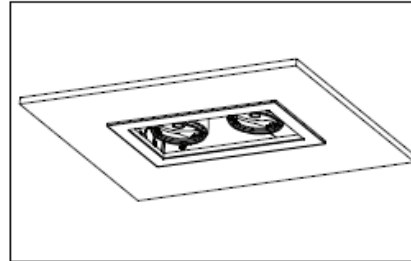

Fig.E



INVISIBLE TRIM INSTALLATION

- Raise screen panel to ceiling opening and secure with screws supplied (as Fig.7 and Fig.8).
- Apply plaster over screen panel and sand surface when dry for a finish look (as Fig.9 and Fig.10).

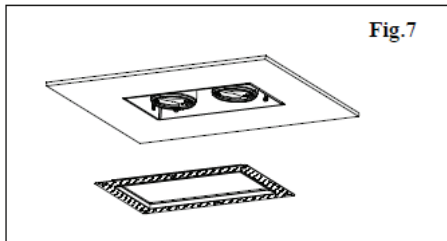

Fig.7

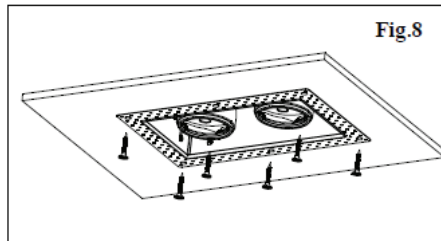

Fig.8

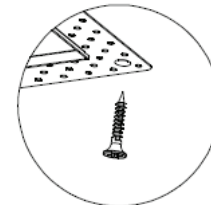

Fig.F

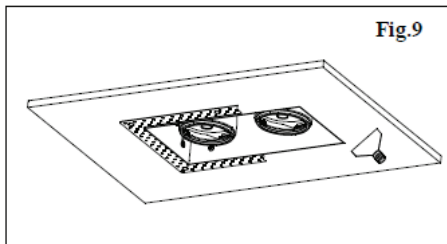

Fig.9

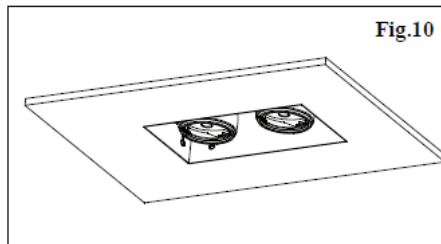

Fig.10

WAC Lighting
www.waclighting.com
Phone (800) 526.2588 • Fax (800) 526.2585

Headquarters/Eastern Distribution Center
44 Harbor Park Drive • Port Washington, NY 11050
Phone (516) 515.5000 • Fax (516) 515.5050

Western Distribution Center
1750 Archibald Ave • Ontario, CA 91761
Phone (800) 526.2588 • Fax (800) 526.2585