

# InvisiLED® CCT

## Color Temperature Selectable Tape



Fixture Type:

Catalog Number:

Project:

Location:

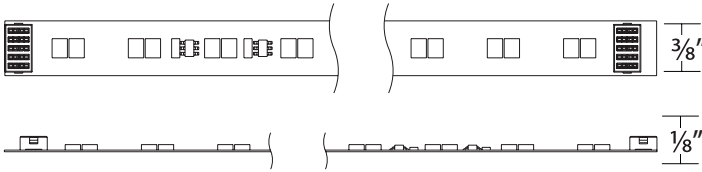

### PRODUCT DESCRIPTION

Architectural grade white tape light that delivers precise color consistency and brightness throughout the strip. 5 CCTs selectable and best-in-lighting quality make it perfect for applications like bright coves or task lighting in dry or damp locations.

### FEATURES

- May be cut and easily reconnected every 4 inches
- Select and choose desirable CCT with matching CCT selectable power supply
- InvisiCoat, a UV stabilized protective coating, protects LEDs and circuitry for long term use in Damp Locations
- Equal brightness for an entire light strip
- Strong adhesive bonding with the 3M adhesive VHB
- Gold plated connector protects from corrosion, heat, and ensures a reliable connection
- 100 ft max distance between the power supply and beginning of InvisiLED®
- Closet Rated options (T24-CS1 & T24-CS2)

### SPECIFICATIONS

- Construction:** Flexible strip light
- Cutting Interval:** 4"
- Input:** 24VDC
- Lumens:** Up to 1000 lm/ft
- Max Run:** Refer to ordering table
- Dimming:** ELV, 0-10V
- CRI:** 95
- McAdams Steps:** 2
- Color Temp:** 2700K / 3000K / 3500K / 4000K / 5000K
- Rated Life:** 50,000 hours
- Operating Temp:** -4°F to 104°F (-20°C to 40°C)
- Standards:** UL & cUL listed, Damp Location listed, Title 24 Compliant

### TAPE SELECTIONS

System	Max Run	Power	Length (in feet)			Color Temp	Finish				
<b>T24-CS1</b> 100+lm/ft	60 ft	1.2W/ft	01	05	10	20	60	2750	3500K	WT	White
<b>T24-CS2</b> 200+lm/ft	40 ft	2.4W/ft	01	05	10	20	40				
<b>T24-CS3</b> 300+lm/ft	30 ft	3.0W/ft	01	05	10	20	30				
<b>T24-CS4</b> 400+lm/ft	20 ft	4.6W/ft	01	05	10	20	N/A				
<b>T24-CS6</b> 600+lm/ft	15 ft	6.3W/ft	01	05	10	15	N/A				
<b>T24-CS10</b> 1000+ lm/ft	10ft	8.5W/ft	01	05	10	N/A	N/A				

Example: **T24-CS10-01-2750WT**

wacighting.com

Phone (800) 526.2588

Fax (800) 526.2585

Headquarters, East Manufacturing Facility

44 Harbor Park Drive

Port Washington, NY 11050

South East Manufacturing Facility

1600 Distribution Ct

Lithia Springs, GA 30122

Central Manufacturing Facility











1700 South J Elmer Freeway, Ste 100

Cedar Hill, TX 75104

West Manufacturing Facility

1750 S Archibald Ave

Ontario, CA 91761

	MODEL	Finish		
	T24-MM-WT	White	Tape to Tape Connector Connects tape sections	
	T24-TI-WT	White	Tape to Tape T Connector Connects tape sections	
	T24-XI-WT	White	Tape to Tape X Connector Connects power feed to tape section	
	T24-LI-WT	White	Tape to Tape L Connector Connects tape sections	
	T24-FF-WT	White	Joiner Cable Extender Connects joiner cable to joiner cable, female on both sides	
	T24-Y-WT T24-Y-BK	White Black	Flex Tape to Tape Y Connector Connects tape sections	
	T24-CT-CL1	Clear	Plastic Mounting Clip For installation on non-flat surfaces Include 10 pcs plastic mounting clips and 10 screws	
	T24-X-WT T24-X-BK	White Black	Flex Tape to Tape X Connector Connects tape sections	
	T24-IC-002 T24-IC-006 T24-IC-012 T24-IC-036 T24-IC-072 T24-IC-144 T24-IC-240	WT White BK Black	In Wall Rated Joiner Cable Connects tape sections, 2 male ends	2 in 6 in 1 ft 3 ft 6 ft 12 ft 20 ft  Example: <b>T24-IC-002-WT</b>
	T24-EX3-072 T24-EX3-144 T24-EX3-240 T24-EX3-1200	WT White BK Black	In Wall Rated Extension Cable Extends distance between a hard wire power supply or a wiring box to a tape section	6 ft 12 ft 20 ft 100 ft  Example: <b>T24-EX3-072-WT</b>
	IR-96-24VDC-CCT-WT IR-96-24VDC-CCT-BK	White Black	IR Sensor IR (Infrared sensor) switch works by turning the light on when it becomes unobstructed	

## Power Supply

	MODEL	Input	Output	Dimming	
	PS-24DC-U60R-CS-SM PS-24DC-U96R-CS-SM	120V-277VAC	24VDC 60W 24VDC 96W	ELV / 0-10V	7 11/16" x 3 7/8" x 1 3/8" > 0.9 pf Overload and short circuit protection Includes 6ft lead wire with connector

Indoor InvisILED tape



- Installs within 5/8" drywall depth
- Linear channel can be field cut
- Accommodates either one or two runs of InvisILED indoor tape
- Includes a frosted acrylic diffuser

**8FT LINEAR CHANNEL**      **LED-T-RCH4-WT**

**Includes:** 1 frosted diffuser  
8 perforated metal sheets

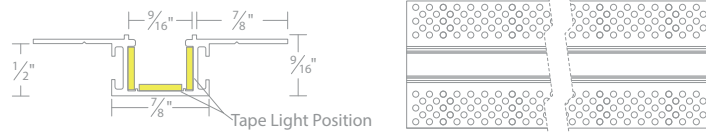

**POWER FEED**      **LED-T-RBOX4-WT**

The end cap may be placed on either side.  
Hanger bars may be installed on any side of the wiring box.

- Includes:** 1 wiring box  
2 hanger bars  
2 end caps  
2 channel connectors  
1 counter sink drill bit  
1 drill bit  
2 power to tape connectors

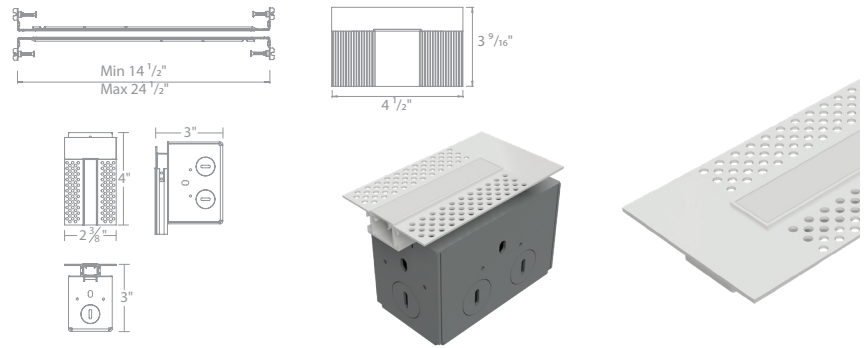

## Trimmed Recessed Slim Channel

Indoor InvisILED tape



- Installs within 5/8" drywall depth
- Linear channel can be field cut
- Accommodates either one or two runs of InvisILED indoor tape
- Includes a frosted acrylic diffuser

**8FT LINEAR CHANNEL**      **LED-T-RCH5-BK**  
**LED-T-RCH5-WT**  
**LED-T-RCH5-AL**

**Includes:** 1 frosted diffuser  
8 perforated metal sheets

**POWER FEED**      **LED-T-RBOX5-BK**  
**LED-T-RBOX5-WT**  
**LED-T-RBOX5-AL**

The end cap may be placed on either side.  
Hanger bars may be installed on any side of the wiring box.

- Includes:** 1 wiring box  
2 hanger bars  
2 end caps  
2 channel connectors  
1 counter sink drill bit  
1 drill bit  
2 power to tape connectors

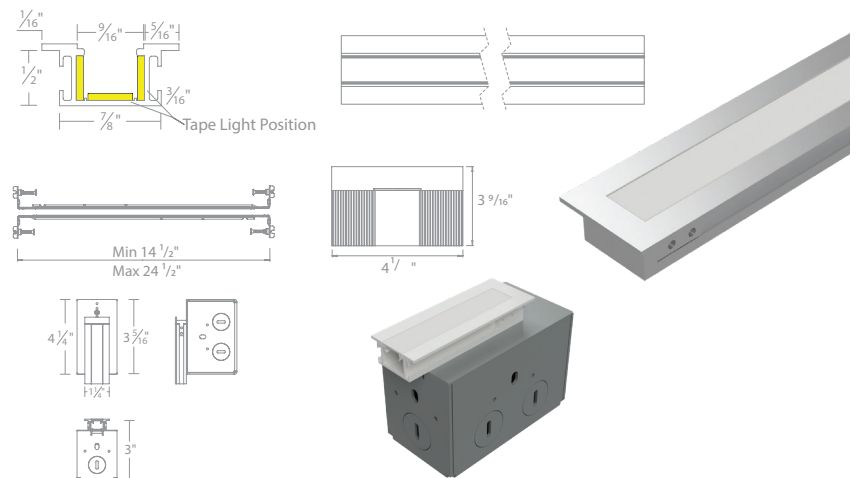

# INVISILED® CCT

## Channels

# WAC

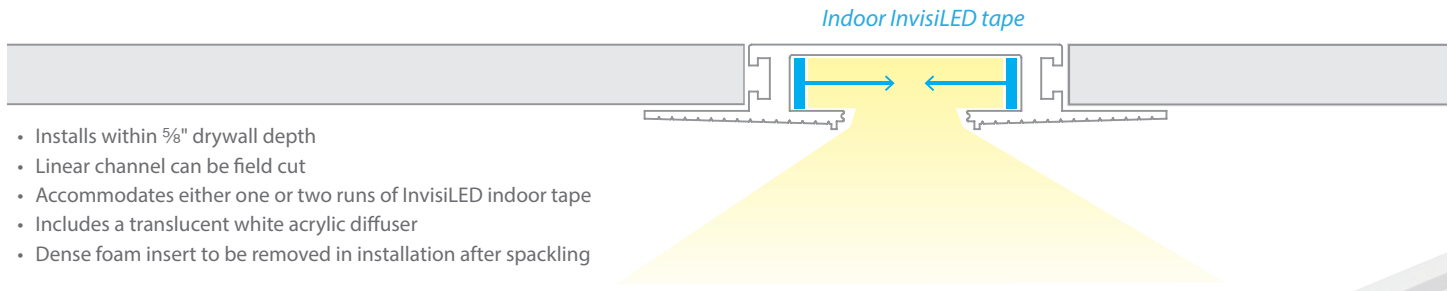

- Installs within 5/8" drywall depth
- Linear channel can be field cut
- Accommodates either one or two runs of InvisiLED indoor tape
- Includes a translucent white acrylic diffuser
- Dense foam insert to be removed in installation after spackling

### 8FT LINEAR CHANNEL LED-T-RCH1-WT

Includes: 1 diffuser  
8 perforated metal sheets

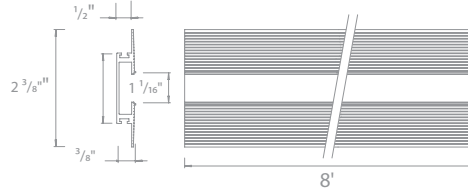

### POWER FEED LED-T-RBOX1-WT

The end cap may be placed on either side.  
Hanger bars may be installed on any side of the wiring box.

- Includes: 1 wiring box  
2 hanger bars  
4 five-pin InvisiLED® adapters  
2 end caps  
1 diffuser  
2 channel connectors  
1 counter sink drill bit  
1 drill bit  
1 installation tool

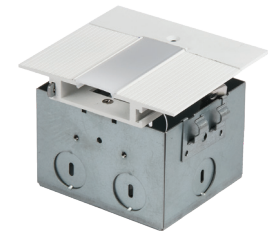
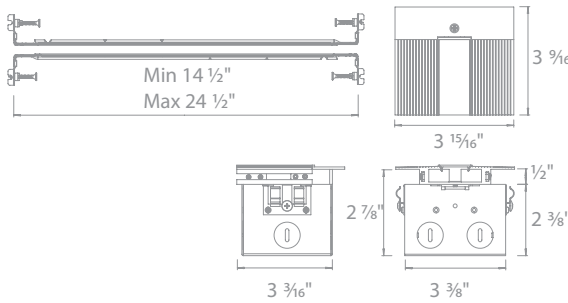

### LATERAL CORNER LED-T-CTC1-WT

- Includes: 1 diffuser  
2 channel connectors  
2 perforated metal sheets

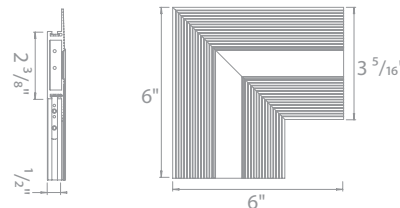

### PERPENDICULAR CORNER LED-T-WTC1-WT

Transitions between walls or wall to ceiling

- Includes: 1 diffuser  
2 channel connectors  
2 perforated metal sheets

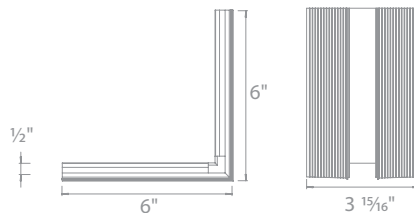

### OUTSIDE CORNER LED-T-WTW1-WT

Transitions around columns, bump outs, or soffits

- Includes: 1 diffuser  
2 channel connectors  
2 perforated metal sheets

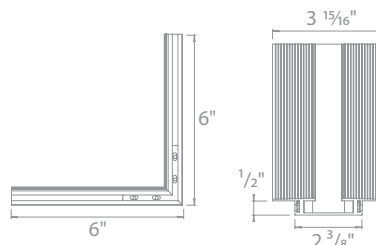

wacighting.com

Phone (800) 526.2588

Fax (800) 526.2585

Headquarters, East Manufacturing Facility

44 Harbor Park Drive

Port Washington, NY 11050

South East Manufacturing Facility

1600 Distribution Ct

Lithia Springs, GA 30122

Central Manufacturing Facility

1700 South J Elmer Freeway, Ste 100

Cedar Hill, TX 75104

West Manufacturing Facility

1750 S Archibald Ave

Ontario, CA 91761

# INVISILED® CCT

## Channels

# WAC

- Installs within 5/8" drywall depth
- Linear channel can be field cut
- Accommodates one run of InvisILED indoor tape
- Dense foam insert to be removed in installation after spackling
- Recommended installation within 15 inches of surface to be illuminated

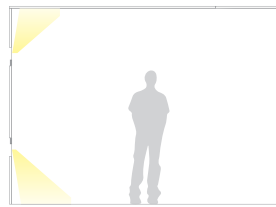

Indoor InvisILED tape

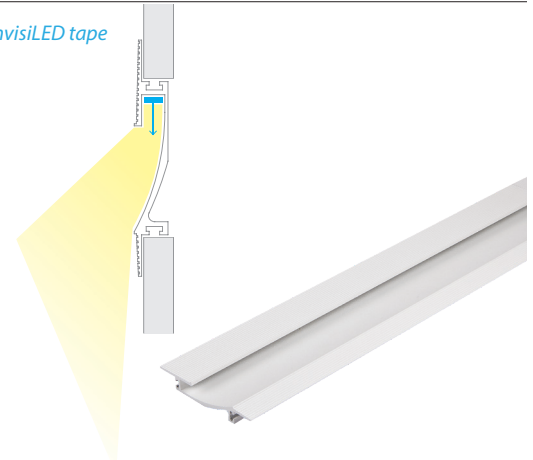

### 8FT LINEAR CHANNEL LED-T-RCH2-WT

Includes: 8 perforated metal sheets  
2 channel connectors

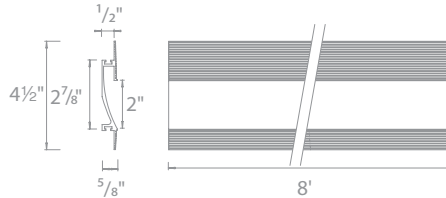

### POWER FEED LED-T-RBOX2-WT

### LED-T-RBOX2-WT

The end cap may be placed on either side. Hanger bars may be installed on any side of the wiring box.

- Includes: 1 wiring box  
2 hanger bars  
2 five-pin InvisILED® adapters  
2 end caps (left and right)  
2 channel connectors  
1 counter sink bit  
1 drill bit

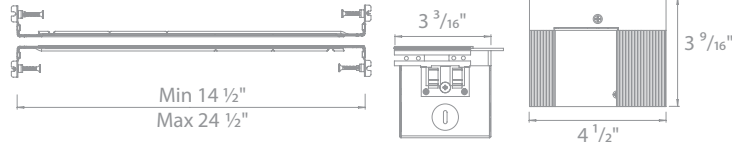

## Indirect Recessed Slim Channel

- Linear channel can be field cut
- Dense foam insert to be removed in installation after spackling
- Allows option to use different color InvisILED in one channel and switch them separately

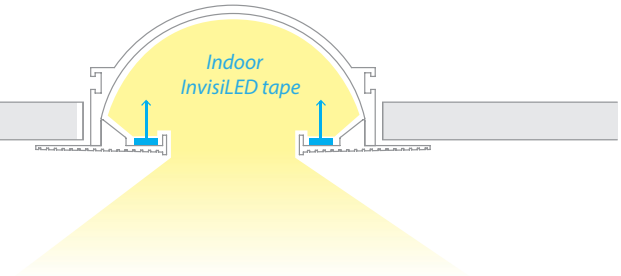
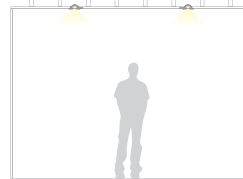

### 8FT LINEAR CHANNEL LED-T-RCH3-WT

Includes: 10 perforated metal sheets  
2 channel connectors

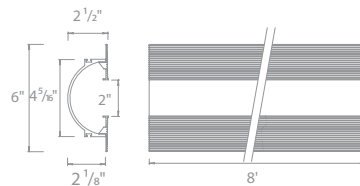

### POWER FEED LED-T-RBOX3-WT

### LED-T-RBOX3-WT

The end cap may be placed on either side.  
Hanger bars may be installed on any side of the wiring box.

- Includes: 1 wiring box  
2 hanger bars  
4 five-pin InvisILED® adapters  
1 end cap  
2 channel connectors  
1 counter sink bit  
1 drill bit

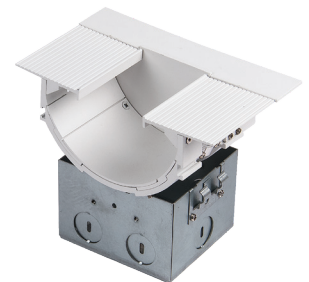
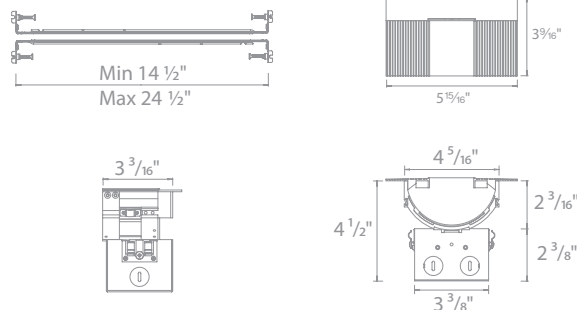

wacighting.com

Phone (800) 526.2588

Fax (800) 526.2585

Headquarters, East Manufacturing Facility

44 Harbor Park Drive

Port Washington, NY 11050

South East Manufacturing Facility

1600 Distribution Ct

Lithia Springs, GA 30122

Central Manufacturing Facility

1700 South J Elmer Freeway, Ste 100

Cedar Hill, TX 75104

West Manufacturing Facility

1750 S Archibald Ave

Ontario, CA 91761

# INVISILED® CCT

## Channels



Indoor InvisiLED tape



- Recessed asymmetrical distribution provides a clean wash of illumination
- Linear channel can be field cut
- Accommodates one run of InvisiLED indoor tape
- Includes a frosted acrylic diffuser

### 5FT LINEAR CHANNEL

LED-T-CH6-BK  
LED-T-CH6-WT  
LED-T-CH6-AL

### ADDITIONAL END CAPS

LED-T-CH6-EC-BK  
LED-T-CH6-EC-WT  
LED-T-CH6-EC-AL

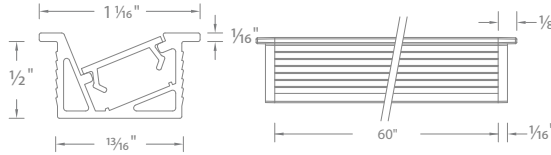

Includes: 1 frosted diffuser  
2 end caps

## Indoor Aluminum Channels

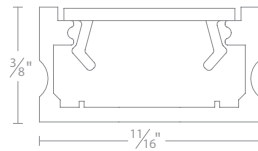

### SHALLOW ALUMINUM CHANNEL

LED-T-CH5-BK  
LED-T-CH5-WT  
LED-T-CH5-AL

5'

### ADDITIONAL END CAPS

LED-T-CH5-EC-BK  
LED-T-CH5-EC-WT  
LED-T-CH5-EC-AL

2 pcs

Includes a diffuser, 2 end caps, and 5 screws.

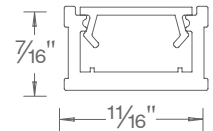

### ALUMINUM CHANNEL ADDITIONAL END CAPS

LED-T-CH  
LED-T-CH-EC

5'  
2 pcs

Diffuses light from InvisiLED tape.  
Includes a diffuser, 2 end caps, and 5 screws.

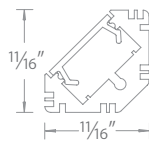

### 45° ANGLED ALUMINUM CHANNEL ADDITIONAL END CAPS

LED-T-CH2  
LED-T-CH2-EC

5'  
2 pcs

Includes a diffuser, 2 end caps, and 5 screws.

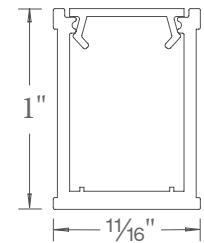

### DEEP ALUMINUM CHANNEL ADDITIONAL END CAPS

LED-T-CH1  
LED-T-CH1-EC

5'  
2 pcs

Eliminates visible hot spots.  
Includes a diffuser, 2 end caps, and 5 screws.

wacighting.com

Phone (800) 526.2588

Fax (800) 526.2585

Headquarters, East Manufacturing Facility

44 Harbor Park Drive

Port Washington, NY 11050

South East Manufacturing Facility

1600 Distribution Ct

Lithia Springs, GA 30122

Central Manufacturing Facility

1700 South J Elmer Freeway, Ste 100

Cedar Hill, TX 75104

West Manufacturing Facility

1750 S Archibald Ave

Ontario, CA 91761

# INVISILED® CCT

## Channels



**ALUMINUM RETROFIT CHANNEL**    **LED-T-RC**    3 feet

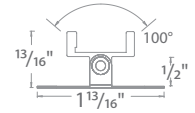

**ADJUSTABLE CHANNEL CLIP**    **LED-T-CL2-PT**

Includes 2 pieces, 4 screws. Used to mount Aluminum Channel.  
Adjust 50° from center either way.

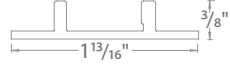

**FIXED ANGLE CHANNEL CLIP**    **LED-T-CL3-PT**

## Optical Channels and Lens Accessories



**FROSTED DIFFUSER**    **LED-T-CH5-COV-FR** 5'  
   **LED-T-CH8-COV-FR** 8'

Standard diffuser included with channel.



**SPOT OPTIC DEEP CHANNEL**    **LED-T-CH3-SP** 5'  
**ADDITIONAL END CAPS**    **LED-T-CH1-EC** 2 pcs

Eliminates visible hot spots.  
Includes a diffuser, 2 end caps, and 5 screws.

Spot 9° Beam Angle



**SEMI-CLEAR DIFFUSER**    **LED-T-CH5-COV-SF** 5'  
   **LED-T-CH8-COV-SF** 8'

Optional diffuser available, order separately.

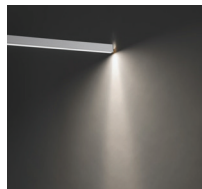

**FLOOD OPTIC DEEP CHANNEL**    **LED-T-CH3-FL** 5'  
**ADDITIONAL END CAPS**    **LED-T-CH1-EC** 2 pcs

Eliminates visible hot spots.  
Includes a diffuser, 2 end caps, and 5 screws.

Flood 54° Beam Angle



**BLACK DIFFUSER**    **LED-T-CH5-COV-BK** 5'  
   **LED-T-CH8-COV-BK** 8'

Optional diffuser available, order separately.

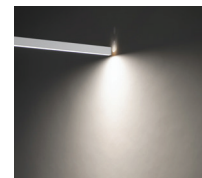

**WIDE FLOOD OPTIC DEEP CHANNEL**    **LED-T-CH3-WF** 5'  
**ADDITIONAL END CAPS**    **LED-T-CH1-EC** 2 pcs

Eliminates visible hot spots.  
Includes a diffuser, 2 end caps, and 5 screws.

Wide Flood 84° Beam Angle

wacighting.com

Phone (800) 526.2588

Fax (800) 526.2585

Headquarters, East Manufacturing Facility

44 Harbor Park Drive

Port Washington, NY 11050

South East Manufacturing Facility

1600 Distribution Ct

Lithia Springs, GA 30122

Central Manufacturing Facility

1700 South J Elmer Freeway, Ste 100

Cedar Hill, TX 75104

West Manufacturing Facility

1750 S Archibald Ave

Ontario, CA 91761